

Anisotropy in the fracture properties of apple flesh as investigated by crack-opening tests

A. A. KHAN, J. F. V. VINCENT

Centre for Biomimetics, Department of Pure and Applied Zoology, University of Reading, Whiteknights, Reading, Berkshire RG6 2AJ, UK

The texture of apple flesh is important in assessing the eating qualities of the fruit. Texture is in turn related to the structure of the parenchyma. Crack-opening tests (wedge penetration tests and notch tensile tests) have shown the tissue to have marked anisotropy in its fracture properties. These differences can be detected by sensitive mechanical instruments and also in the mouth. The flesh of the apple is split much more easily along the fruit's radius than, for example, in a direction parallel to the fruit's tangent. This was shown with the fracture tests as well as discriminated by a taste panel. In tangential orientation the wedge, or teeth, have to penetrate to a greater distance exerting a greater force to initiate a free-running crack, and fracture toughness is about 50% greater than in radial orientation. The mechanical behaviour of apple parenchyma is directly related to its structural composition. The radially elongated intercellular spaces ease the passage of radially travelling cracks, i.e. along the direction of the spaces, and act as crack stoppers and crack deflectors to tangentially travelling cracks, i.e. at right angles to the spaces. This increases the energy requirement for crack propagation for tangential cracks hence increasing the fracture toughness in that orientation.

1. Introduction

One of the important components of the perceived texture of food is the way in which it deforms and breaks during biting. Much of our appreciation of what we eat depends on the food's fracture properties. The mechanical properties of the food depend largely on its structure and composition, and any variations in structure will influence its mechanical properties and hence the texture.

Biological materials are commonly anisotropic, hence their mechanical properties differ according to the orientation in which it is tested. Fleshy fruit tissue, such as apple parenchyma, shows mechanical anisotropy depending on the shape and arrangement of the cells and other morphological components. Large and elongated intercellular spaces have been reported in apples and other fruit [1, 2]. It is possible that these spaces, together with the arrangement of the cells, make the material mechanically anisotropic. The contribution of the structural factors to the mechanical behaviour of apple parenchyma has been largely overlooked, yet this property to a very large extent influences the oral perception of the fruit's texture. The limited amount of work that has been done on the textural properties of fruit assumes the structure to be isotropic [3]. Tensile testing on apple tissue has been carried out previously but the effects of orientation have not been investigated [4]. Recent work reveals that the morphological components in apple parenchyma greatly influence its mechanical properties and cannot be ignored [5, 6].

This present work investigated the fracture properties of apple parenchyma taking the orientation of structures into consideration and shows how the fracture toughness and strength depend on the direction of travel of the crack generated by a controlled mechanical test or by the teeth.

1.1. Structure of apple parenchyma

An apple can be regarded as a sphere of tough fibrous skin [7] filled with a matrix of a closed-cell foam making up the parenchymatous flesh or cortex. The cells immediately underneath the skin are small and radially flattened with their maximum dimension about 50 μm . Progressing inwards there is a gradual increase in cell size until about 5 mm from the surface when they reach their maximum diameter [8]. Cell length could be up to 100–200 μm [1] depending on the variety [2]. The greatest increase in dimension is in the radial orientation. The interior cells become increasingly radially elongated and begin to organise themselves into radial columns diverging from near the centre of the fruit to its periphery [2]. Most of the cortex therefore consists of radially elongated cylindrical cells stuck end to end radiating outwards in distinct columns (Fig. 1).

Mature apple parenchyma has a relative density of less than 1, usually 0.5–0.9 [9]. It contains large intercellular spaces which are clearly visible under a microscope [1]. These intercellular spaces show a similar orientation from the surface to the centre, as

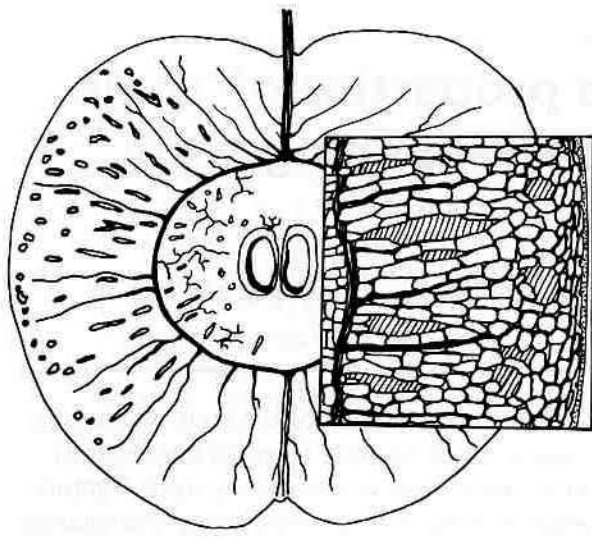

Figure 1 Diagrammatic representation (not to scale) of the orientation of cells, intercellular spaces and vascular strands within the apple cortex. Cells and spaces near the surface are spherical and less well orientated, whereas those further in are radially elongated and orientated into radial columns. Shaded areas represent intercellular spaces and thick solid lines represent vascular strands.

do the cells [2]. The outer spaces are roughly spherical with a diameter of about 100–200 μm and randomly distributed. Progressing inwards they begin to become radially elongated and lie in between the radial columns of cells. They can be up to about 3 mm long and 50–100 μm diameter. The volume of intercellular spaces has been estimated as about 20%–25% [10] and 27% for Granny Smith [8]. In most varieties it varies between about 25% and 40% [9].

There are radially diverging vascular strands arising from the dense vascular area that lies between the inner and the outer cortex and extending to the periphery of the fruit [1]. They consist of a bundle of lignified fibres much smaller in cross-section ($< 20 \mu\text{m}$) than the parenchyma cells [2]. These radially orientated structures makes apple parenchyma morphologically anisotropic. In investigating the mechanical properties of apple flesh these directional differences must therefore be considered, a concept ignored by all previous workers on fruit and vegetable texture. This paper reports the effect of structural anisotropy on the stiffness and fracture properties of apple flesh in a few varieties of apples.

2. Materials and methods

Crack-opening (wedge-penetration and tensile) tests were performed on geometrically cut specimens of apple parenchyma in an Instron testing machine to measure

- the failure force, F_f – the recorded force at the point of initiation of a free-running crack;
- the failure stress, σ_f – the stress in the specimen at the point of crack initiation. $\sigma_f = F_f/a$ (where a is the cross-sectional area of the specimen);
- the failure distance, S_f – the distance of penetration of the wedge when a free-running crack starts;
- the failure strain, ε_f the strain at the point of crack initiation. $\varepsilon_f = \delta h_f/h_0$ (where δh_f is the change

in height of the specimen at the point of crack initiation and h_0 is the original height of the specimen);

(e) the fracture toughness, R – the energy, I , required to generate a new surface of unit area. $R = I/a_c$ (where a_c is the crack area).

The apple varieties used were Bramley, Cox, Gloster, Norfolk Beefing and Rock Pippin.

2.1. Orientation

A free-running crack can progress in one of three primary planes set at right-angles to each other: x, y, z ; x, z ; and y, z (Fig. 2). In each of the three planes there are two main directions of crack propagation, shown by arrows 1–6. A crack can therefore proceed in one of six possible directions (Fig. 2). 1 and 5 are identical where the crack passes along the direction of, and in a plane parallel to the cell columns (along); 2 and 6 are identical where the crack passes at right-angles to the above, but still in a plane parallel to cell columns (across); 3 and 4 are identical where the crack transverses the cell columns (through). Only one of each replicate pair needs to be considered. Additionally, “along” and “across” are equivalent, because they are both parallel to the cell columns. Only two of the three possible orientations were therefore investigated: 1 and 3. The terms “radial” and “tangential” will be used to describe these two orientations, respectively, which will refer to the orientation of the crack; radial, where the crack propagates radially to the fruit and along the cell columns, and tangential, where the crack propagates parallel to the tangent of the fruit and through the cell columns.

2.2. Wedge penetration tests

Wedge penetration tests [11] were done on rectangular blocks of flesh measuring 12 mm \times 12 mm \times 6 mm cut from the cortex using a pair of microtome blades mounted parallel and set apart to a required distance. The blocks were then bisected by a 30° wedge mounted on the Instron at a constant speed of 1 mm min⁻¹. The specimens were cut so that the wedge (or crack) moved either radially or tangentially (Fig. 3a). The test was continued until a reasonably sized free-running crack had developed ahead of the wedge tip. The force–distance curve was plotted and this was used, with the crack area, to calculate the fracture toughness and also force and distance of penetration at the point of failure. Twelve tests were done on each variety of apple in each orientation.

As the intercellular spaces and cells in the inner part of the cortex are much more radially orientated than the outer part of the cortex it is possible that there are differences in the mechanical properties between the two regions. Wedge penetration tests were performed on Gloster apple flesh taking cubical specimens of 6 mm sides from the inner and outer part of the cortex and tested, as before, with a 30° wedge. The total width of the cortex in Gloster is about 30 mm.

2.3. Tensile tests

Tensile crack-operating tests were carried out on notched specimens so that during the test a crack is

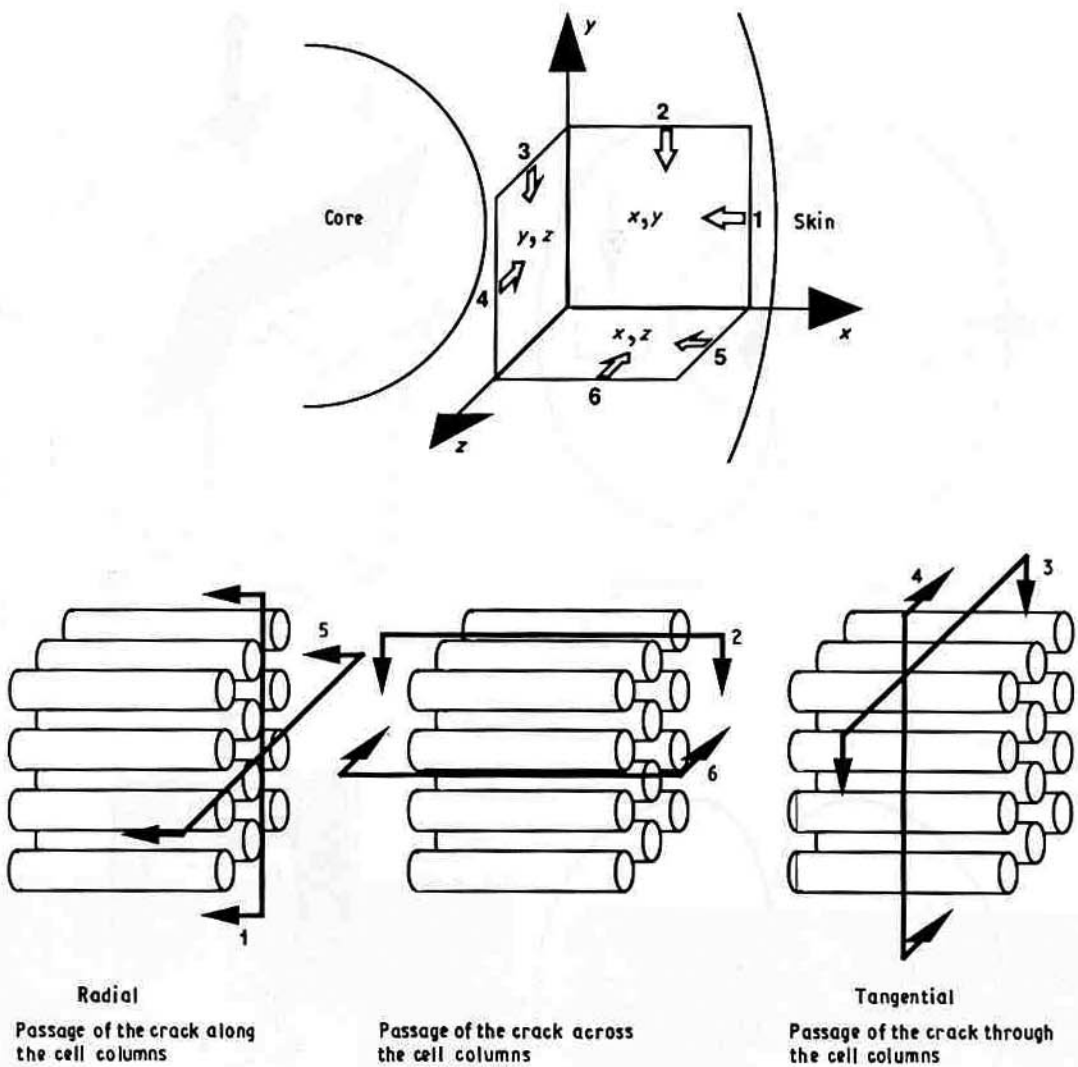

Figure 2 Diagram of all the possible orientations in which a free-running crack can propagate within the apple cortex. (a) Within the three primary planes, x, y, z and y, z the crack can advance in six possible directions as shown by arrows 1–6. (b) The cell columns and possible crack planes. Cracks can pass along the columns (1, 5); across (2, 6) or through (3, 4). Only orientations 1 and 3 are considered termed radial and tangential, respectively. (See text for details.)

made to propagate from the tip of the notch in either radial or tangential orientation. Strips of apple flesh length 8 mm, width 6 mm, thickness 2 mm and notch depth 3 mm were cut from the apple in the radial and tangential orientations (Fig. 3b). They were cut longer than the required length and the ends were stuck down with superglue to aluminium plates held 8 mm apart which were then gripped by the pneumatic clamps of the Instron. The specimen was stretched at 0.5 mm min^{-1} until a crack starting at the notch traversed the entire specimen. The energy required to split the specimen and the crack area were used to calculate the fracture toughness. Ten tests were performed for both tangential and radial orientations. A similar series of tests was performed on unnotched specimens to measure the breaking stress and strain in the two directions.

2.4. Panel tests

It is in the mouth that “texture” is ultimately perceived. A taste panel session was carried out in conjunction with Horticulture Research International,

East Malling, Kent. Twelve panellists, each of whom was presented with four cubes of apple flesh (Gloster) of about 15 mm sides cut from the quarters of the same fruit and were asked to bite them with their incisors down the mid-line as in a wedge test and stop biting when the specimen broke in two. The initiation of a crack is indicated by a fall in the force on the jaws. The cubes were cut so that each panellist was biting two pieces radially (sample R) and two tangentially (sample T). They did not know the orientation of the specimens or the expected result. They were asked three questions (comments on the reason for these questions are also given which did not appear on the questionnaire).

1. Which specimen splits more easily? (related to the energy required to break the specimen in two and hence fracture toughness.)

2. Which has greatest tooth penetration before split occurs? (related to the distance of penetration at failure point and hence strain energy.)

3. Which specimen requires more force to bite? (related to the force at failure point and hence strength.)

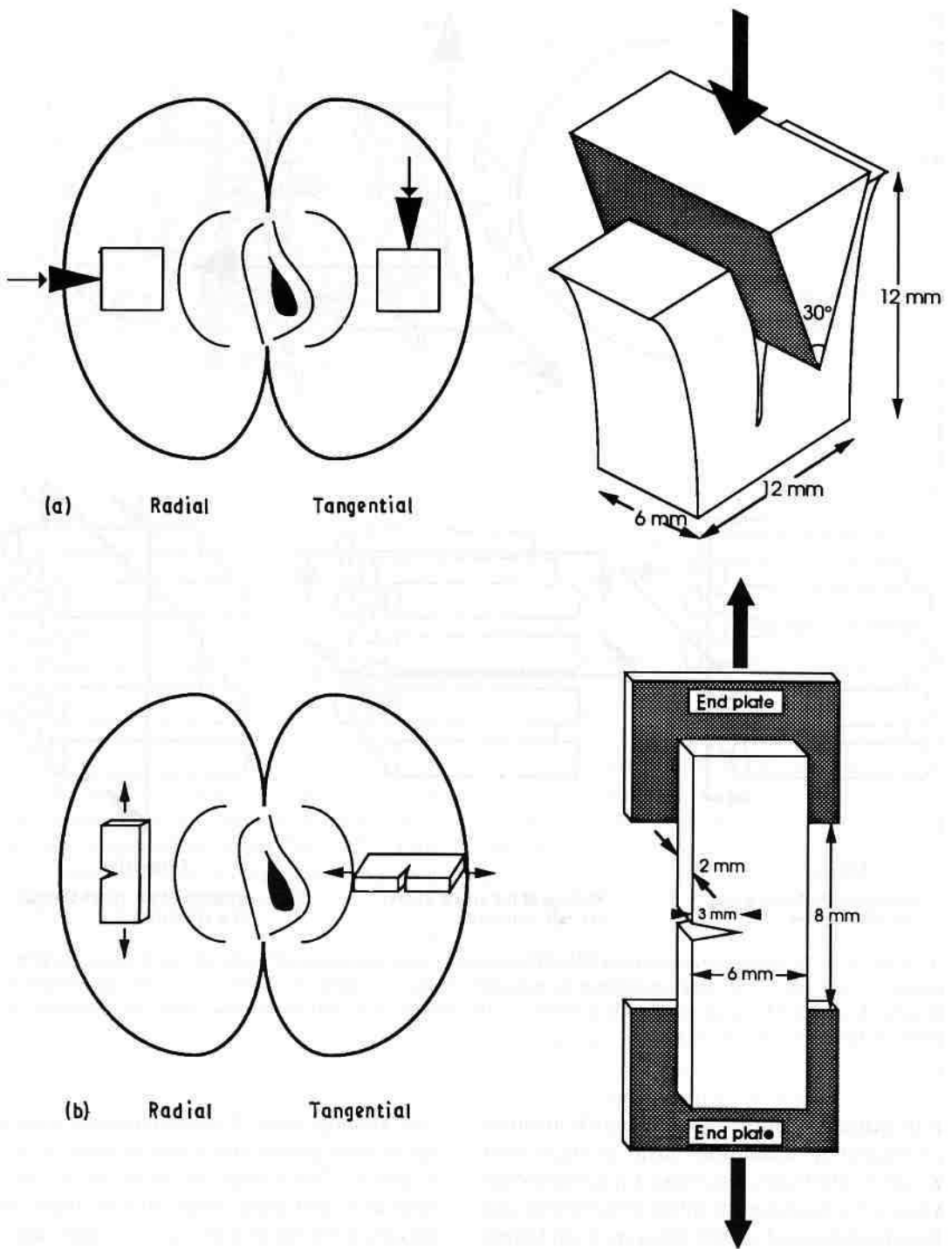

Figure 3. Orientation and dimensions of the specimens for radial and tangential (a) wedge penetration test and (b) tensile test. The arrows show the direction in which the wedge travels or the specimen stretched.

The broken specimens clearly indicated the distance of tooth penetration. The zone of tooth penetration has expelled sap on the surface as a result of cell rupture. The zone of free-running fracture where the crack passed in between the cells was dry. This was measured accurately for analysis.

3. Results

3.1. Wedge penetration

Fig. 4a shows the crack paths of radial and tangential specimens in relation to the fruit and the force-distance traces with the events occurring at various

stages of the test. Fig. 5a and b show photographs of the fractured specimens in the two orientations. In the radial orientation the wedge begins to cut and bend the two halves apart, storing strain energy in them as indicated by the increasing force reading. Stress is concentrated at the wedge tip and at failure a crack is initiated at the tip. The force falls as the crack extends away in the same direction as the wedge.

In tangential orientation, initially the difference is not apparent as the wedge cuts through in the same way although usually slightly higher forces are recorded suggesting that the tissue is tougher in that orientation. The wedge has to penetrate much further

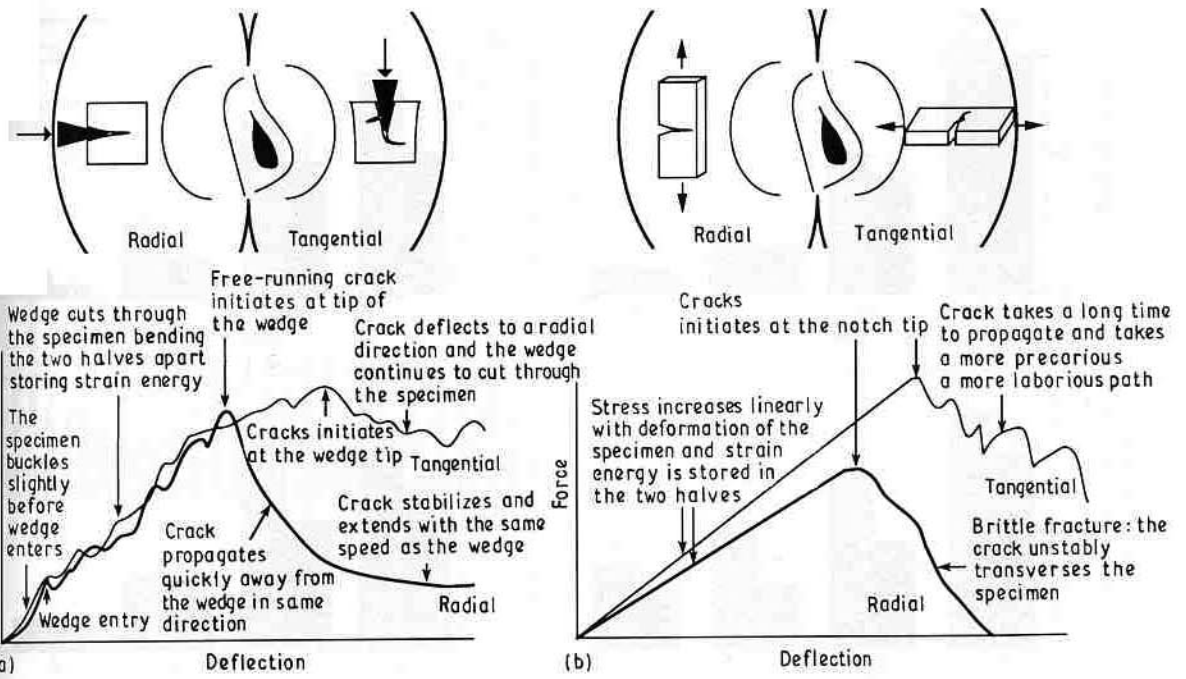

Figure 4 Fractured radial and tangential specimens in (a) wedge test and (b) tensile test showing the crack paths. It is easier for the crack to travel radially to the fruit than tangentially. A tangential crack usually deflects to a radial direction on a large scale in the wedge test or at a cellular scale in the tensile test. The force–deflection curves show the events occurring at various stages.

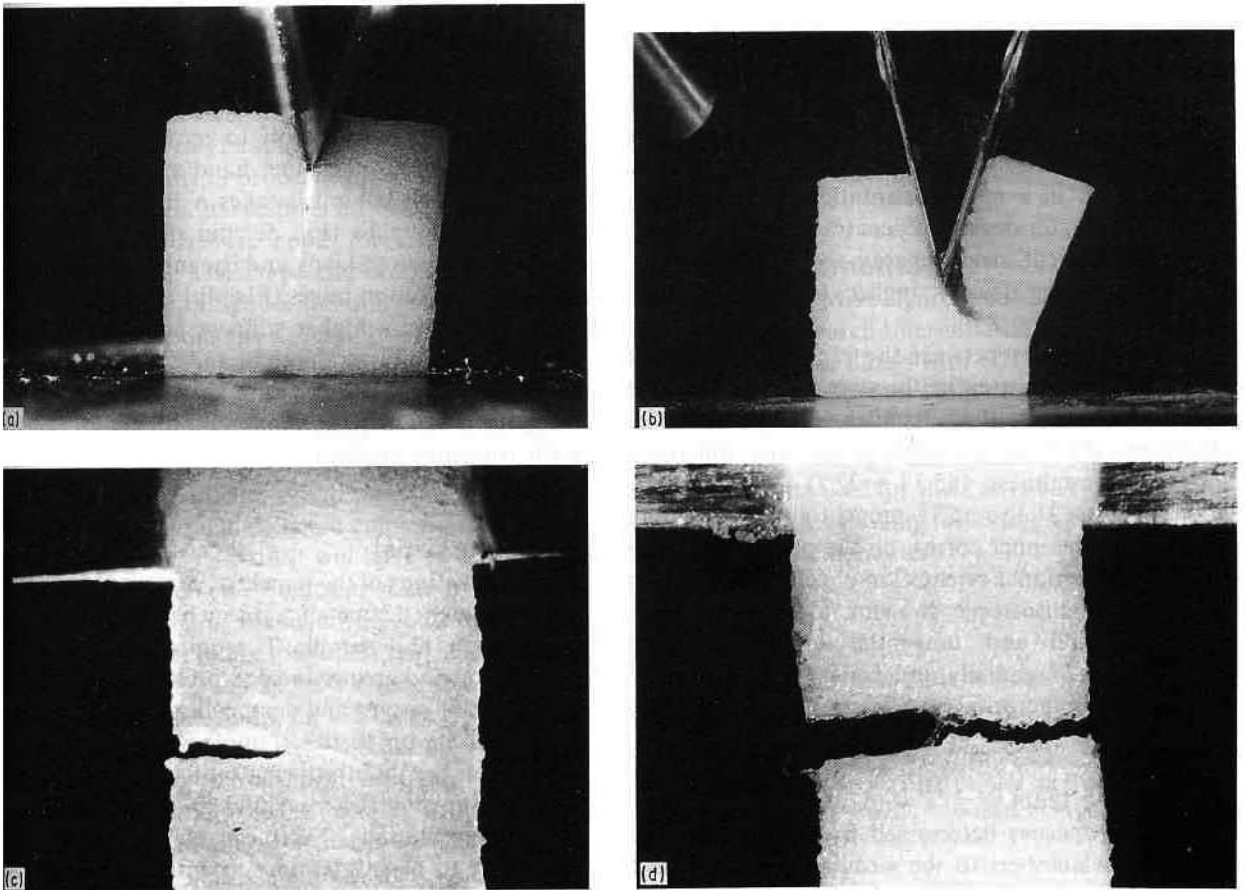

Figure 5 Fractured specimens showing the crack paths in (a) radial wedge, (b) tangential wedge, (c) radial tensile and (d) tangential tensile tests.

to initiate a crack indicating that a greater amount of energy has to be stored and hence greater fracture toughness. Usually the crack starts at the tip of the wedge but it is soon deflected obliquely to one side.

Occasionally the tissue tears from the side of the wedge. With an oblique crack the wedge continues cutting and the force reading does not fall as with radial orientation.

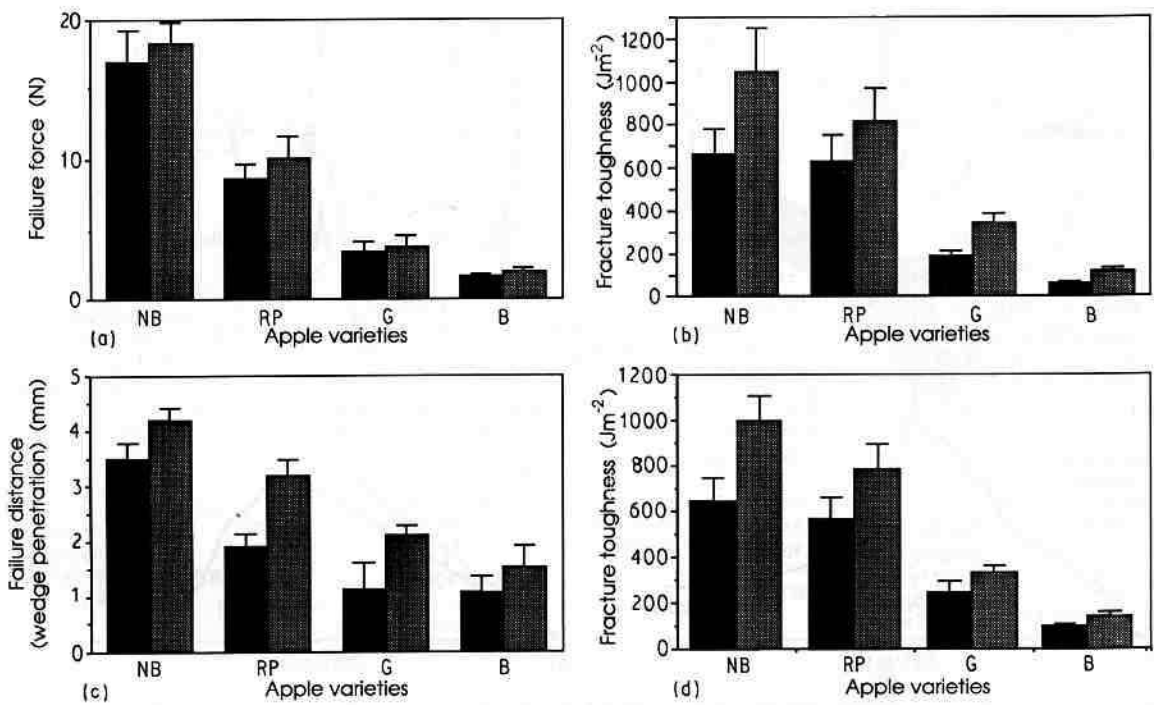

Figure 6 Radial and tangential (a) failure force ($n = 12$; $p < 0.05$), (b) failure distance ($n = 12$; $p < 0.01$) and (c) fracture toughness ($n = 12$; $p < 0.01$) in a variety of apples as determined by the wedge penetration test. (d) Radial and tangential fracture toughness ($n = 10$; $p < 0.01$) in a variety of apples as determined by tensile test on notched specimens. NB, Norfolk Beefing; RP, Rock Pippin; G, Gloster; B, Bramley. (■) radial, (■) tangential.

Fig. 6 shows calculated values of failure force (a) and distance (b), and fracture toughness (c) in the two orientations. The anisotropy is very apparent especially for fracture toughness values where the same material in a tangential orientation can be 40% tougher than in a radial orientation. As a result, it requires a greater degree of penetration of the wedge to store sufficient strain energy to initiate a crack. Failure force is usually higher tangentially than radially.

There is variation between the fracture toughness of outer and inner cortex in the two orientations. The outer cortex, where there is much less orientation of structures, shows only a slight anisotropic difference in fracture toughness: $185.3 (\pm 27.3) \text{ J m}^{-2}$ radially and $293.3 (\pm 31.1) \text{ J m}^{-2}$ tangentially (a factor of about 0.6). The inner cortex, on the other hand, with its highly directional orientation of cells and spaces is much more anisotropic showing a huge difference between radial and tangential toughness: $263.0 (\pm 52.9) \text{ J m}^{-2}$ radially and $686.0 (\pm 92.4) \text{ J m}^{-2}$ tangentially (a factor of 1.6).

3.2. Tensile tests

Fracture properties determined by tensile tests give very similar numbers to the wedge penetration tests because the mechanism of crack opening is very similar. Tension causes strain energy to build up in the two halves of the specimen with the stress concentration highest at the notch tip. At failure the energy is released into initiating and propagating a free-running crack from the tip of the notch. In both orientations the crack advances across the width of the specimen, travelling either radially or tangentially. Fig. 4b shows

the crack paths in relation to the entire fruit. A radial crack (along the cell columns) travels with ease and fracture is brittle accompanied by a clicking noise. The measured stress falls rapidly to zero as the specimen breaks in two. On the other hand a tangential crack (across the cell columns) takes a much slower and more winding path (Fig. 5c and d) with the force reading decreasing slowly and irregularly as shown by the force-deflection traces (Fig. 4b). Tangential specimens also have a higher stiffness and higher failure stress and failure strain than radial ones. Fracture toughness values (Fig. 6d) are similar to those from wedge tests and likewise about 40% higher for tangentially travelling cracks than radially travelling ones.

3.3. Taste panel

The observations of the panellists presented in Fig. 7a shows a high degree of agreement. Sample R split more easily and sample T required greater tooth penetration and greater force to break. The results are extremely consistent and demonstrate that anisotropy in the fracture properties of apple flesh can be clearly detected in the mouth during biting. Fig. 7b is a bar diagram showing the measured tooth penetration in the two orientations. The mean values indicate that teeth have to penetrate more than twice the distance when travelling across the cell columns than along the columns.

4. Discussion

The implications of anisotropy of apple flesh are far ranging. The radial orientation of cells and spaces

Question	1	2	3	4	5	6	7	8	9	10	11	12
1	RR	RR	RR	RR	RT	RR	RR	RR	RR	RR	RR	RR
2	TT	TT	TR	TT	TT	TT	TT	TT	RR	RT	TT	TT
3	TT	TT	TT	TT	TR	TT	TT	TT	TT	TT	TT	TT

(a)

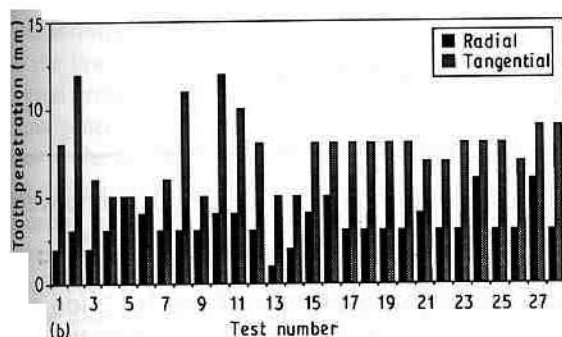

(b)

Radial	Tangential
Mean = 3.36 mm	Mean = 7.69 mm
S.D. = 1.13	S.D. = 1.99 mm
$n = 24$ $p < 0.001$	

Figure 7 (a) Observations of the panellists on the texture of Gloster apple when biting in the radial (R) and tangential (T) orientations. The question numbers correspond to those listed in the text. (b) Tooth penetration in the radial and tangential orientations as measured from panel tests. The statistics show the result of a *t*-test.

makes apple parenchyma mechanically different depending on the direction of loading and it has been shown that this affects the oral perception of apple texture. The fruit can be split much more easily radially than tangentially, a property which must influence its eating qualities, harvesting, transport and storage properties. In a mature apple the crack travels in between cells [5]. The shape and arrangement of the cells, the intercellular spaces and other structural components therefore dictate, to varying degrees, the crack path, crack stability, strength and fracture toughness. The radially elongated intercellular spaces ease the passage of cracks travelling along them by acting as built-in notches and stress concentrators. They act as crack stoppers and deflectors to the cracks travelling at right angles to them. When a crack tip runs into a space lying across its path it will have to start a new crack on the other side. Sufficient stress has to build up again at the blunt tip requiring extra energy and hence increasing fracture toughness and failure strain. In both wedge and tensile tests cracks travelling radially can propagate along the cell columns and intercellular spaces with great ease and almost in a brittle fashion. This is why a segment of apple broken by hand along the radius breaks unstably with a clicking sound. When a radial crack reaches a space it continues in the other side with no extra expenditure of energy. It is also likely that the cell columns are not firmly stuck to each other and as a result can be separated relatively easily. This orientation requires least energy to fracture. By contrast, cracks travelling at right angles to cell columns have to take a much more jagged route around the radially elongated cells and also have to traverse cell columns, a more energy-requiring mechanism of fracture than radial cracking.

Higher forces suggest that there is much greater adhesion between individual cells within each column than between adjacent columns. When an advancing crack reaches an intercellular space lying across its path, the crack tip, which is the site of highest stress concentration, is made "blunt". To initiate a new crack is an energy-requiring process. Tests on a variety of apples have shown that to initiate and propagate a crack over an area of 6 mm² requires twice the energy than just to propagate a free-running crack over the same area [5]. Failure stress and strain, and fracture toughness are therefore much higher for apple flesh tangentially than radially. This confirmed by the fact that the highly orientated inner cortex is much more mechanically anisotropic than the less-orientated outer cortex.

Crack-opening and taste panel tests have yielded very conclusive evidence on the anisotropic behaviour of apple parenchyma. Textural anisotropy is a collective result of many morphological factors contributing to a greater or lesser extent including cell size, shape, orientation and adhesion, mechanical properties and orientation of vascular material, size, shape and orientation of intercellular spaces. Only the effect of voids is considered in any detail here. They have been shown to dictate to a large extent the crack path, strength and fracture toughness of the material. The anisotropic orientation of these spaces makes the material behave very differently according to the direction in which it splits. It is important to consider orientation of the specimen during handling, transport, storage and processing of fruit and vegetables, an aspect almost completely ignored by the industry.

Acknowledgements

We thank Drs Mike Knee and Stephen Hatfield, Horticulture Research International, East Malling, for their support and, along with RHS Wisley, for supplying the apples. Drs Peter Lillford and Geoff Attenborough, Unilever Research, Colworth Laboratory, and Dr George Jeronimidis, University of Reading, are thanked for their advice. We also thank all the staff of East Malling for setting up and participating in the taste panel test.

References

1. R. M. REEVE, *Food Res.* **18** (1953) 604.
2. A. A. KHAN and J. F. V. VINCENT, *J. Sci. Food Agric.* **48** (1990) 455.
3. T. T. LIN and R. E. PITT, *J. Tex. Studies* **17** (1986) 291.
4. D. SCHOORL and J. E. HOLT, *ibid.* **14** (1983) 155.
5. A. A. KHAN, PhD thesis, University of Reading (1989).
6. J. F. V. VINCENT, *Adv. Bot. Res.* **17** (1990) 235.
7. A. MEYER, *Proc. Amer. Soc. Hort. Sci.* **45** (1944) 105.
8. J. M. BAIN and R. N. ROBERTSON, *Aust. J. Sci. Res.* **B4** (1951) 75.
9. J. F. V. VINCENT, *J. Sci. Food Agric.* **47** (1989) 443.
10. C. STERLING, *Recent Adv. Food Sci.* **3** (1963) 259.
11. J. F. V. VINCENT, G. JERONIMIDIS, A. A. KHAN and H. LUYTEN, *J. Tex. Studies* **22** (1991) 45.

Received 6 August 1991
and accepted 22 November 1992